

Congratulations on your choice of a MBQuart speaker. This "Quick Start Installation" guide is meant to help you "hook up" and play music. For more detailed information on system setting, speaker and subwoofer configuration, and full specifications by model, visit the website at MBQuart.com



CAUTION

Always consider consulting a professional audio installer before installing new speakers. Many car manufacturers locate speakers behind interior panels that require special tools to remove those panels to access the speakers. Some panels will be screwed in, some will use plastic fasteners, many will have both. Be careful and take your time.

If you are using the speaker wire supplied with your new speakers make sure that you run the speaker wires through the factory boot. Do not let speaker wire make contact with metal edges of doors or other access holes.

Speaker dimensions

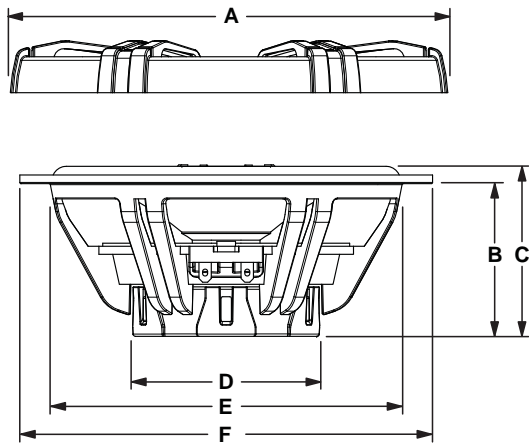

	A	B	C	D	E	F
XK1-113	6.7"(169)	2.2"(55)	2.4"(62)	3.1"(79)	4.5"(114)	5.0"(128)
XK1-116	6.9"(176)	2.4"(61)	2.7"(68)	3.1"(79)	5.6"(142)	6.5"(166)
XK1-169	7.5"/10.5" (190/267)	3.1"(78)	3.4"(86)	3.6"(91)	5.8"/8.7" (146/221)	6.6"/9.4" (167/238)
XC1-216	6.9"(176)	2.4"(61)	2.7"(68)	3.1"(79)	5.6"(142)	6.5"(166)

Before you start

It's a good idea to confirm that you have purchased the correct size speakers to fit your vehicle. If you have any reservations about being able to complete the installation yourself, we recommend contacting a professional. The removal of interior panels can be tricky and may require special tools. Be careful as you go.

Factory speaker removal

A Access and remove factory door speakers

Most modern vehicles have speakers that are mounted directly to the structure of the door. Access is achieved by the removal of the door panel. Some vehicles may only require the removal of a small panel around the speaker itself.

B Access and removal of rear factory speakers

Most rear speakers are accessed from within the trunk. Some may require the removal of the rear package tray. Hatchbacks and SUV's will usually require the removal of a side panel.

C Fit and Wiring

Once the factory speakers are removed, check the fit and determine if there is enough depth clearance for the new speaker. A good way to do this is to roll the window down and back up while holding the speaker in place. If you decide to run wires, make sure to use factory harness boots and grommets where ever possible.

Coax installation

A Factory location behind door panel

Once you are sure the speaker fits and has adequate clearance, connect the positive and negative wires to the proper terminals. Securely screw the speaker into place. Replace door panel.

B Factory location behind small panel

Once you are sure the speaker fits and has adequate clearance, connect the positive and negative wires to the proper terminals. Securely screw the speaker into place. Replace speaker cover panel.

C Custom location

Some vehicles may not have a door speaker location. While it is possible to install the speakers in this situation, it is more difficult. Consider using a professional for custom installations.

D Rear factory locations

Mount the speakers in same way that the factory speaker was mounted. Attach the positive and negative wires to the proper terminals. Make sure any wires are secured properly.

Component installation

A Factory location behind door panel

Vehicles that have premium sound systems will often have separate tweeters in a dash or door location. Try to use this location for mounting the component tweeter if possible.

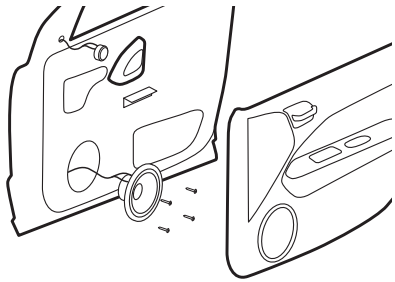

B Custom location

If there is not a suitable factory location for woofer or tweeter to be mounted, custom mounting may be necessary. Before making any permanent changes to your vehicle make sure there is adequate mounting depth.

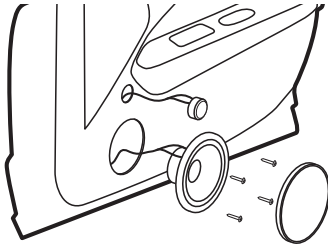

C Crossover wiring

The crossover is necessary for the proper operation of the component speaker system. Make sure the wires are securely attached and that there are no stray strands of wire contacting other terminals. Mount the crossover to a secure surface that is free of interference from window mechanisms and excessive moisture.

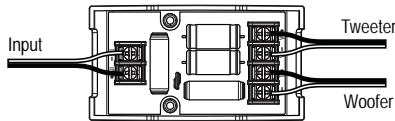

D Tweeter mounting

There are three primary ways the tweeter can be mounted. Surface, Flush and Angled mounting. Make sure to check for any obstructions before cutting into any panel.

Flush Mount



Surface Mount

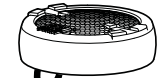

Angled Mount

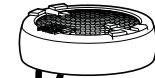

MBQuart.com
#MUSICDEFINED

WARRANTY

Maxxsonics USA Inc. warrants this product, to the original consumer purchaser, to be free from defects in material and workmanship for a period of one (1) year from the date of purchase. Maxxsonics USA Inc. will, at its discretion, repair or replace defective products during the warranty period. Components that prove to be defective in materials and workmanship under proper installation and use must be returned to the original authorized Maxxsonics USA Inc. retailer from where it was purchased. A photocopy of the original receipt must accompany the product being returned. The costs associated with removal, re-installation and freight are not the responsibility of Maxxsonics USA Inc. This warranty is limited to defective parts and specifically excludes any incidental or consequential damages connected therewith. To view the full warranty, please visit the website.

MBQuart products are designed and engineered in the USA by

MAXXSONICS®

847-540-7700

www.maxxsonics.com

MBQ X-Line spk QSG 01 - rev2

MBQUART®
MUSIC. DEFINED.

Quick Start Installation Guide

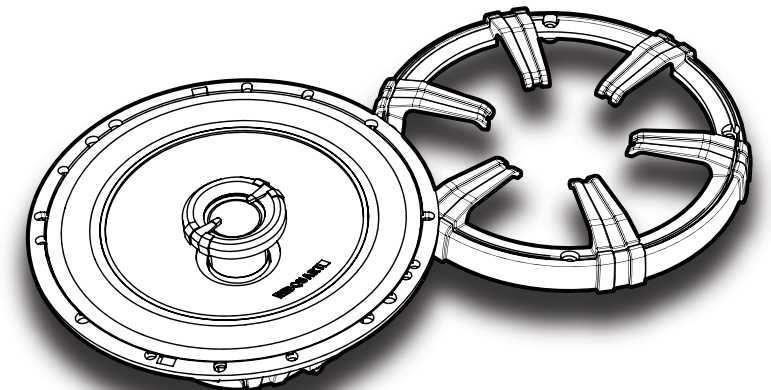

X-LINE

XK1-113

XK1-116

XK1-169

XC1-216